

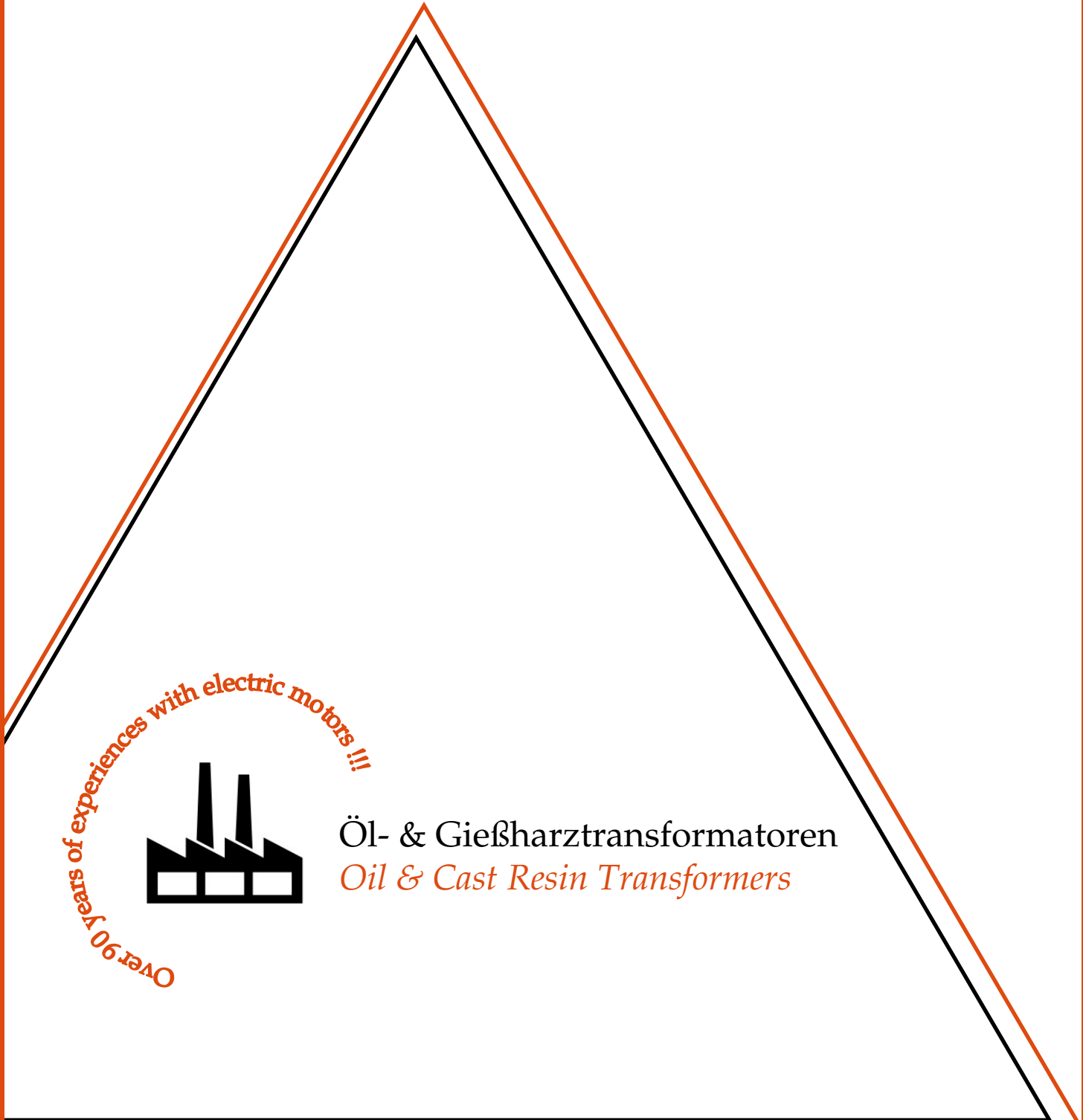

Hansa-Motoren

Transformatoren *Transformers*



Over 90 years of experiences with electric motors !!!

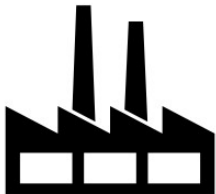

Öl- & Gießharztransformatoren
Oil & Cast Resin Transformers



Inhalt / Topic	Seite / Page
Grundlagen / <i>Basics</i>	01
Öltransformator / <i>Oil transformer</i>	03
Gießharztransformator / <i>Cast resin transformer</i>	07





Grundlagen

Basics

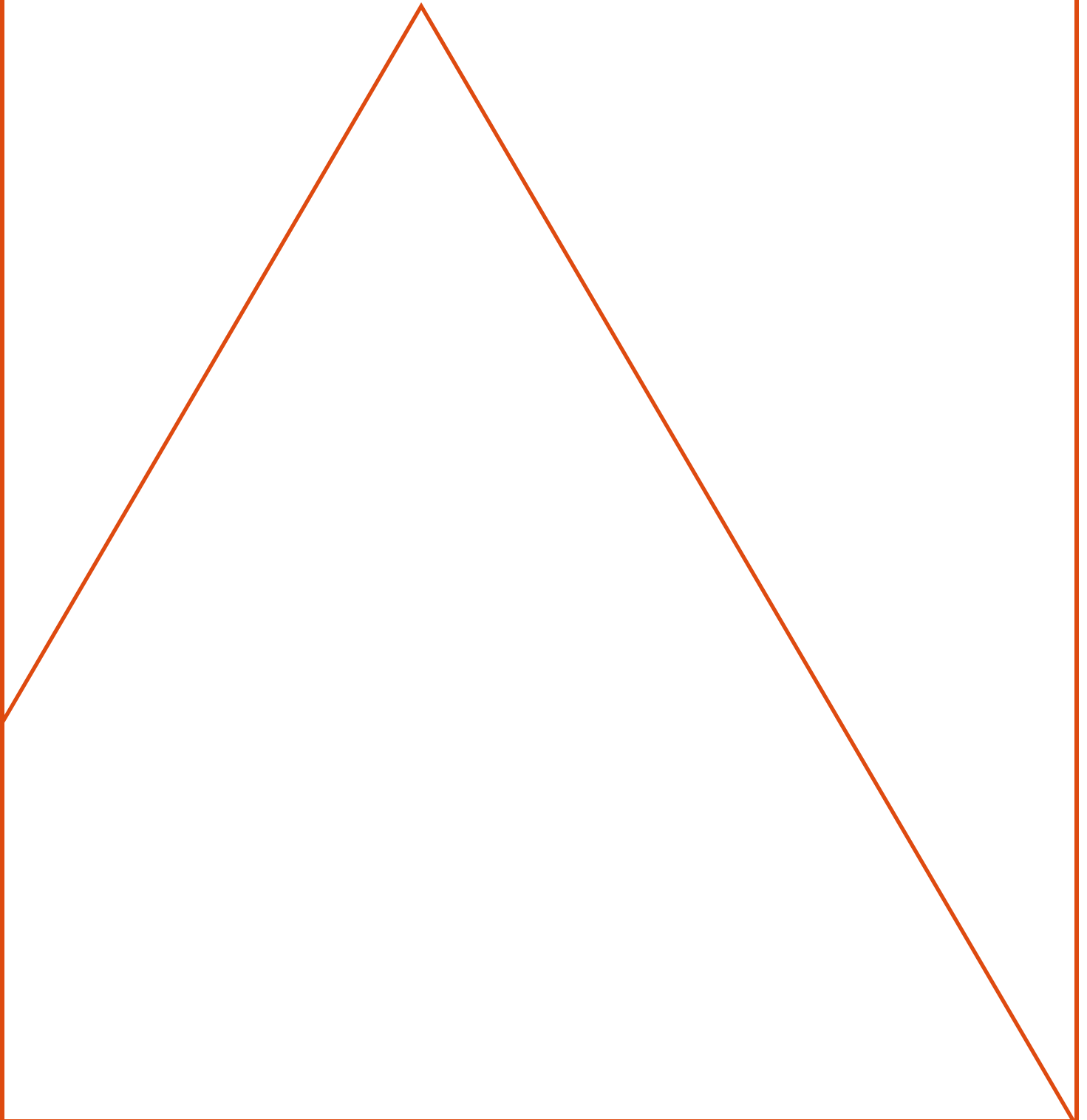



Normen / Norm

Die Öl-Transformatoren entsprechen folgenden Normen :

CEI EN 60076-1 (IEC 60076-1), IEC 50464-1 (Klassifizierung CEI : CEI 14-34) CEI 14-13, HD 428.1 S1

Die Gießharz-Transformatoren entsprechen folgenden Normen :

CEI EN 60076-1, CEI EN 60076-11, HD 538.1 S1

The oil transformers comply with the following standards :

CEI EN 60076-1 (IEC 60076-1), IEC 50464-1 (Klassifizierung CEI : CEI 14-34) CEI 14-13, HD 428.1 S1

The cast resin transformers comply with the following standards :

CEI EN 60076-1, CEI EN 60076-11, HD 538.1 S1

Allgemeine Eigenschaften / General feature

Primärspannung : bis 22,8 kV $\pm 2 * 2,5\%$
*Primary voltage : up to 22,8 kV $\pm 2 * 2,5\%$*

Sekundärspannung : 400 V + Neutral
Primary voltage : 400 V + neutral

Schaltgruppe : D Y N 11 - 5 - 7 - 1
Primary voltage : D Y N 11 - 5 - 7 - 1

Frequenz : 50 Hz
Frequency : 50 Hz





Öltransformator

Oil transformer

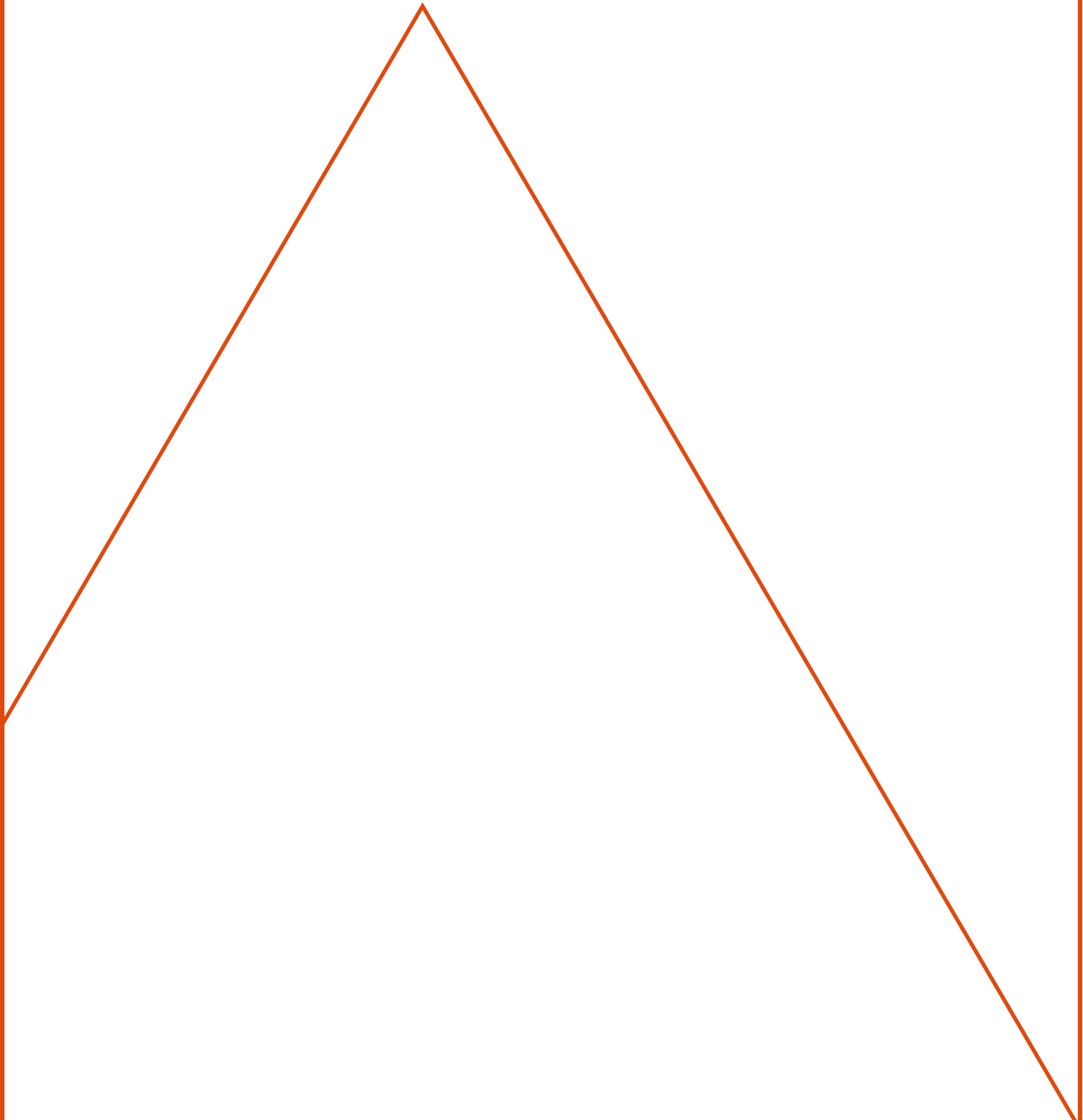



Standardverluste / Standard losses

Type	Leistung <i>Power</i>	Kurzschluss- spannung <i>Impedance voltage</i>	Leerlauf- strom <i>No-load current</i>	Leerlaufverluste <i>No-load losse</i>	Verluste (75°C) <i>Losses (75°C)</i>	Ölgewicht <i>Oil weight</i>	Gesamtgewicht <i>Total weight</i>
HMTO...	kVA	V_{clc} (%)	I_0 (%)	P_0 (W)	P_{clc} (W)	kg	kg
50S	50	4	0,5	200	1.400	70	350
100S	100	4	0,5	320	2.400	100	500
160S	160	4	0,5	450	3.500	140	650
200S	200	4	0,5	450	4.400	145	700
250S	250	4	0,5	650	4.700	200	900
315S	315	4	0,5	700	5.650	230	1.000
400S	400	4	0,5	800	7.200	250	1.150
500S	500	4	0,6	950	8.000	310	1.450
630S	630	4	0,6	1.150	10.800	410	1.850
630S	630	6	0,8	1.150	10.800	420	1.800
800S	800	6	0,8	1.300	12.800	460	2.000
1000S	1.000	6	0,8	1.500	14.500	550	2.400
1250S	1.250	6	0,8	1.900	17.200	620	2.750
1600S	1.600	6	0,8	2.200	19.500	730	3.200
2000S	2.000	6	0,8	2.500	28.500	880	3.900
2500S	2.500	6	0,8	3.150	30.000	1.000	4.600

Normalverluste / Normal losses

Type	Leistung <i>Power</i>	Kurzschluss- spannung <i>Impedance voltage</i>	Leerlauf- strom <i>No-load current</i>	Leerlaufverluste <i>No-load losse</i>	Verluste (75°C) <i>Losses (75°C)</i>	Ölgewicht <i>Oil weight</i>	Gesamtgewicht <i>Total weight</i>
HMTO...	kVA	V_{clc} (%)	I_0 (%)	P_0 (W)	P_{clc} (W)	kg	kg
50N	50	4	0,5	180	1.100	90	370
100N	100	4	0,5	320	1.750	140	550
160N	160	4	0,5	450	2.350	180	740
200N	200	4	0,5	550	2.850	200	800
250N	250	4	0,5	650	3.250	250	1.000
315N	315	4	0,5	750	3.800	270	1.150
400N	400	4	0,5	900	4.500	320	1.350
500N	500	4	0,5	1.100	5.450	350	1.550
630N	630	4	1,0	1.300	6.500	480	1.900
630N	630	6	1,0	1.200	6.500	470	1.850
800N	800	6	1,0	1.400	8.200	550	2.200
1000N	1.000	6	1,0	1.700	10.500	580	2.400
1250N	1.250	6	1,0	2.100	13.100	680	2.900
1600N	1.600	6	1,0	2.500	17.000	740	3.250
2000N	2.000	6	1,0	3.000	21.000	900	4.000
2500N	2.500	6	1,0	3.500	26.500	1.050	4.700
3150N	3.150	6	1,0	3.900	30.500	1.350	5.750





Reduzierte Verluste / Reduced losses

Type	Leistung <i>Power</i>	Kurzschluss- spannung <i>Impedance voltage</i>	Leerlauf- strom <i>No-load current</i>	Leerlaufverluste <i>No-load losse</i>	Verluste (75°C) <i>Losses (75°C)</i>	Ölgewicht <i>Oil weight</i>	Gesamtgewicht <i>Total weight</i>
HMTO...	kVA	V _{clc} (%)	I ₀ (%)	P ₀ (W)	P _{clc} (W)	kg	kg
50R	50	4	0,2	125	875	120	430
100R	100	4	0,2	210	1.475	190	660
160R	160	4	0,2	300	2.000	240	900
200R	200	4	0,2	360	2.400	260	1.000
250R	250	4	0,2	425	2.750	310	1.150
315R	315	4	0,2	500	3.200	330	1.400
400R	400	4	0,2	610	3.650	380	1.600
500R	500	4	0,2	720	4.600	430	1.900
630R	630	4	0,5	860	5.400	550	2.150
630R	630	6	0,5	800	5.600	550	2.150
800R	800	6	0,5	930	7.000	580	2.450
1000R	1.000	6	0,5	1.100	9.000	670	2.900
1250R	1.250	6	0,7	1.300	11.000	700	3.200
1600R	1.600	6	0,7	1.700	14.000	770	3.500
2000R	2.000	6	0,7	2.100	18.000	900	4.000
2500R	2.500	6	0,7	2.500	22.000	1.100	4.900
3150R	3.150	6	0,7	3.000	26.000	1.500	6.700

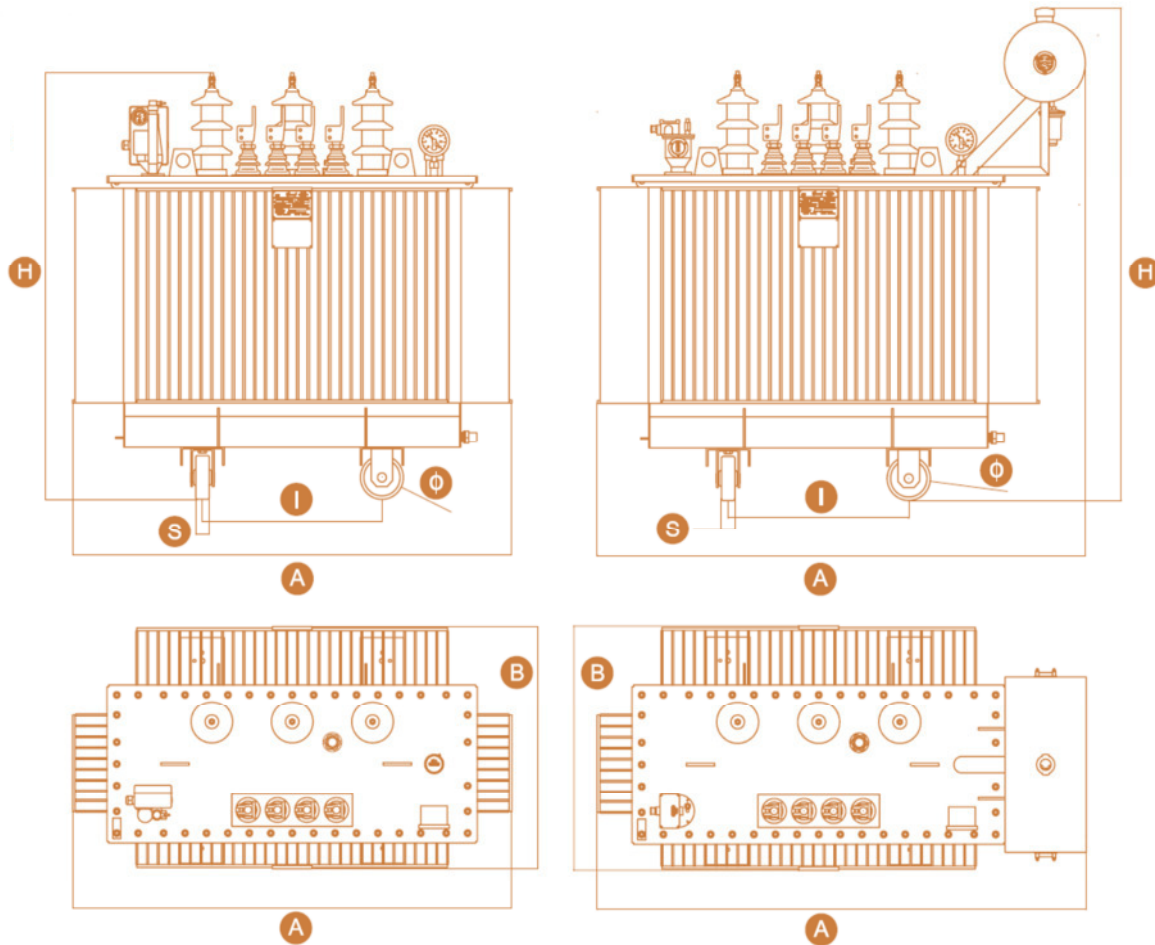

Abmessungen / Dimensions

Type	A			B			H			Φ	S	I
	S	N Öl / Hermetisch Oil / Hermetic	R Öl / Hermetisch Oil / Hermetic	S	N	R	S	N Öl / Hermetisch Oil / Hermetic	R Öl / Hermetisch Oil / Hermetic			
HMTO...	mm			mm			mm			mm	mm	mm
50.	1.100	1.150 / 850	1.200 / 950	650	550	650	1.350	1.350 / 1.200	1.400 / 1.250	125	40	420
100.	1.100	1.250 / 1.000	1.350 / 1.050	700	700	700	1.450	1.450 / 1.300	1.500 / 1.350	125	40	420
160.	1.200	1.350 / 1.050	1.450 / 1.150	750	750	700	1.500	1.500 / 1.350	1.550 / 1.400	125	40	420
200.	1.350	1.400 / 1.150	1.450 / 1.200	750	750	700	1.500	1.500 / 1.400	1.650 / 1.500	125	40	520
250.	1.450	1.350 / 1.100	1.500 / 1.200	800	800	800	1.550	1.600 / 1.500	1.650 / 1.500	125	40	520
315.	1.450	1.450 / 1.200	1.500 / 1.300	900	800	900	1.550	1.600 / 1.450	1.700 / 1.500	125	40	520
400.	1.550	1.500 / 1.400	1.650 / 1.450	900	900	950	1.650	1.600 / 1.450	1.800 / 1.600	125	40	670
500.	1.600	1.650 / 1.450	1.700 / 1.400	1.050	900	950	1.700	1.750 / 1.550	1.850 / 1.650	125	40	670
630.	1.800	1.850 / 1.650	1.750 / 1.750	1.000	900	950	1.800	1.850 / 1.600	1.850 / 1.700	160	50	670
630.	1.800	1.850 / 1.650	1.750 / 1.750	1.000	900	950	1.800	1.850 / 1.600	1.850 / 1.700	160	50	670
800.	1.850	1.850 / 1.650	1.850 / 1.650	1.000	950	1.000	1.850	1.850 / 1.650	1.950 / 1.700	160	50	670
1000.	1.900	1.850 / 1.700	1.900 / 1.700	1.200	1.050	1.000	1.850	1.900 / 1.700	2.100 / 1.850	160	50	820
1250.	1.900	2.000 / 1.950	2.050 / 1.900	1.150	1.200	1.100	2.050	1.950 / 1.750	2.050 / 1.800	160	50	820
1600.	2.100	2.100 / 2.050	2.000 / 2.000	1.200	1.200	1.150	2.050	2.050 / 1.800	2.100 / 1.850	160	50	820
2000.	2.250	2.200 / 2.200	2.150 / 2.150	1.350	1.300	1.300	2.150	2.200 / 1.950	2.250 / 2.000	200	70	1.070
2500.	2.250	2.300 / 2.300	2.400 / 2.400	1.350	1.400	1.400	2.300	2.300 / 2.050	2.400 / 2.050	200	70	1.070
3150.	-	2.450 / 2.450	2.600 / 2.400	-	1.400	1.500	-	2.500 / 2.150	2.450 / 2.150	200	70	1.070



Gießharztransformator

Cast resin transformer

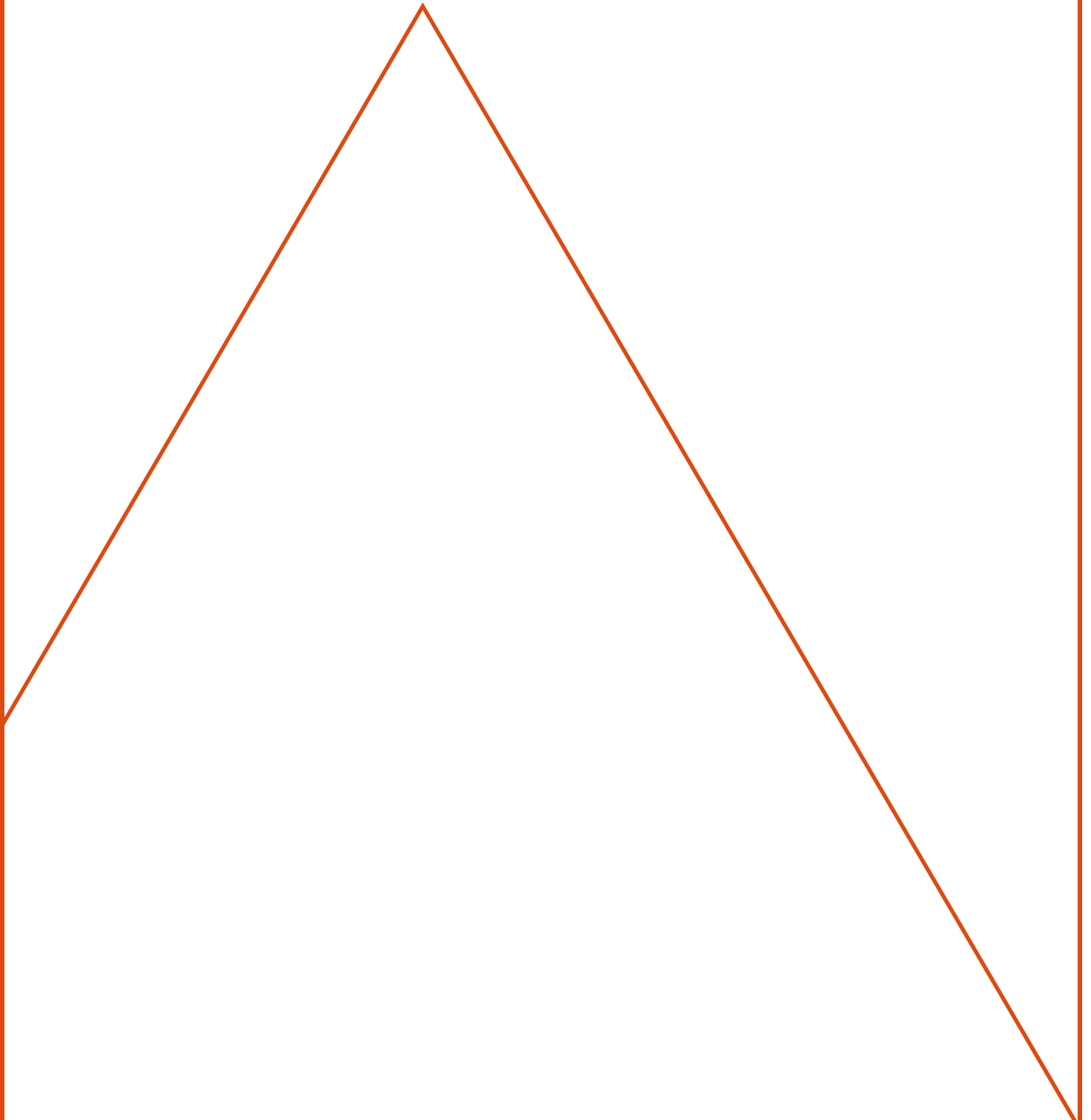



Normalverluste / Normal losses

Type	Leistung <i>Power</i>	Kurzschluss- spannung <i>Impedance voltage</i>	Leerlauf- strom <i>No-load current</i>	Leerlaufverluste <i>No-load losse</i>	Verluste (75°C) <i>Losses (75°C)</i>	Gesamtgewicht <i>Total weight</i>
HMTG...	kVA	V _{sc} (%)	I ₀ (%)	P ₀ (W)	P _{dc} (W)	kg
100N	100	6	1,35	460	1.700	570
160N	160	6	1,00	650	2.500	730
200N	200	6	0,75	800	3.000	800
250N	250	6	0,60	850	3.300	1.000
315N	315	6	0,50	990	4.100	1.150
400N	400	6	0,40	1.200	4.800	1.350
500N	500	6	0,40	1.400	5.900	1.500
630N	630	6	0,35	1.650	6.900	1.800
800N	800	6	0,30	2.000	8.100	2.100
1000N	1.000	6	0,30	2.300	9.600	2.500
1250N	1.250	6	0,30	2.700	11.600	2.900
1600N	1.600	6	0,30	3.100	14.000	3.400
2000N	2.000	6	0,25	4.000	17.000	4.000
2500N	2.500	6	0,25	4.800	20.000	4.700
3150N	3.150	6	0,20	5.600	23.000	5.700

Reduzierte Verluste / Reduced losses

Type	Leistung <i>Power</i>	Kurzschluss- spannung <i>Impedance voltage</i>	Leerlauf- strom <i>No-load current</i>	Leerlaufverluste <i>No-load losse</i>	Verluste (75°C) <i>Losses (75°C)</i>	Gesamtgewicht <i>Total weight</i>
HMTG...	kVA	V _{sc} (%)	I ₀ (%)	P ₀ (W)	P _{dc} (W)	kg
100R	100	6	1,20	360	1.700	700
160R	160	6	0,95	500	2.500	800
200R	200	6	0,75	700	2.850	900
250R	250	6	0,60	750	3.100	1.200
315R	315	6	0,50	800	3.600	1.350
400R	400	6	0,40	950	4.200	1.500
500R	500	6	0,40	1.150	5.400	1.700
630R	630	6	0,35	1.350	6.500	1.950
800R	800	6	0,30	1.650	7.900	2.400
1000R	1.000	6	0,30	1.900	9.600	2.750
1250R	1.250	6	0,30	2.150	10.500	3.250
1600R	1.600	6	0,30	2.600	12.500	4.100
2000R	2.000	6	0,25	3.500	15.000	4.350
2500R	2.500	6	0,25	4.000	18.000	5.200
3150R	3.150	6	0,20	5.000	20.500	6.000





Abmessungen / Dimensions

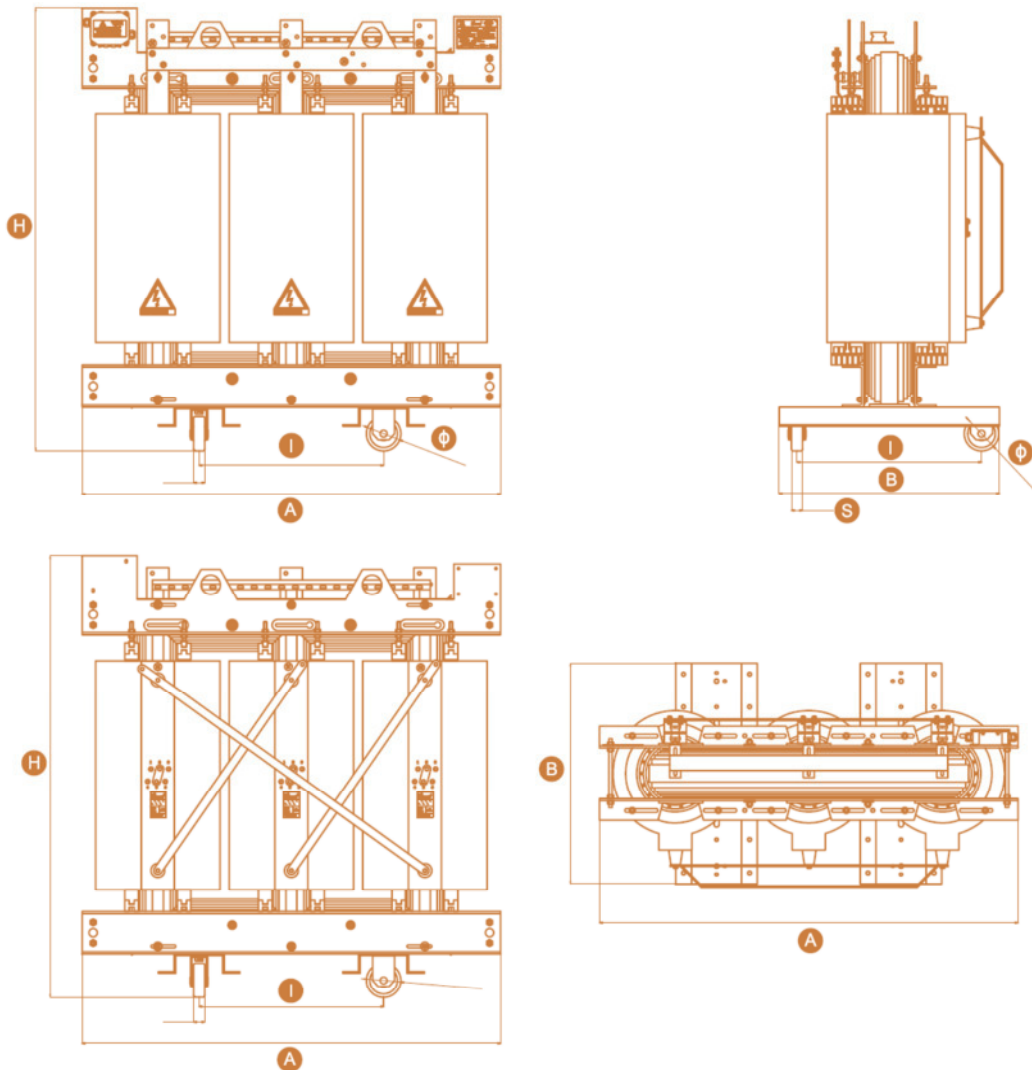

Type	A		B		H		Φ	S	I
	N	R	N	R	N	R			
HMTG...	mm		mm		mm		mm	mm	mm
100.	1.120	1.210	650	650	1.080	1.200	125	40	520
160.	1.210	1.210	650	650	1.100	1.210	125	40	520
200.	1.210	1.210	650	650	1.270	1.440	125	40	520
250.	1.290	1.350	800	800	1.380	1.460	125	40	670
315.	1.290	1.370	800	800	1.460	1.570	125	40	670
400.	1.320	1.390	800	800	1.580	1.570	125	40	670
500.	1.430	1.430	800	800	1.590	1.360	125	40	670
630.	1.520	1.520	800	800	1.610	1.640	125	40	670
800.	1.560	1.560	800	800	1.830	1.850	125	40	670
1000.	1.620	1.675	990	990	1.910	2.050	160	50	820
1250.	1.650	1.680	990	990	2.070	2.170	160	50	820
1600.	1.740	1.880	990	990	2.180	2.260	160	50	820
2000.	1.890	1.890	1.270	1.270	2.280	2.270	200	70	1.070
2500.	1.950	1.900	1.270	1.270	2.310	2.350	200	70	1.070
3150.	2.100	1.970	1.270	1.270	2.370	2.430	200	70	1.070





Hansa-Motoren

Reparaturbetrieb GmbH
Dannenkamp 26-28
D-22869 Schenefeld b. Hamburg

Tel. : +49 (0)40 / 853 771 – 0
Fax : +49 (0)40 / 853 771 – 33
Mail : info@hansa-motoren.de
Web : www.hansa-motoren.de

Technische Änderungen und Irrtümer vorbehalten. / *Technical modifications reserved, errors excepted.*